

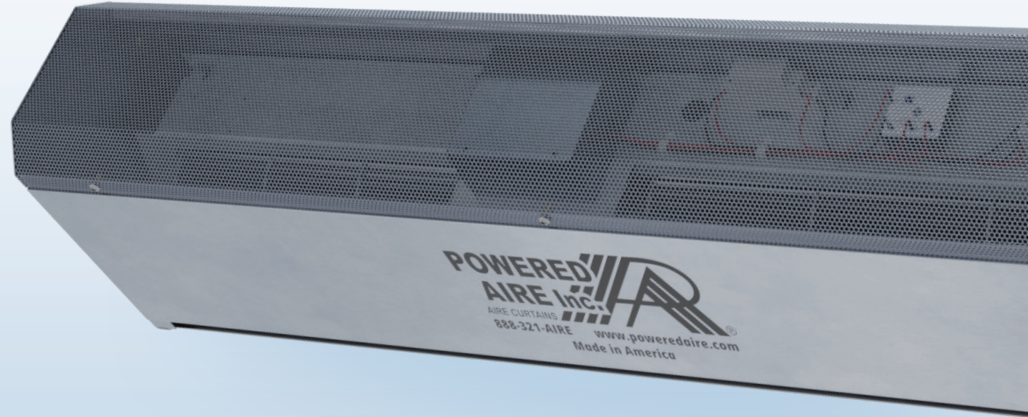

MP-E



The Mini-Power's with electric heat (MP-E) compact low-profile design is ideal for entrances where space is limited. The MP air curtain from Powered Aire has met all criteria to be used as an exception to vestibules as well as being tested in accordance with the ANSI/AMCA 220 standard. The MP-E model is often seen in toll booths (for fume control), zoos/amusements parks, food trucks, cannabis grow houses, restaurants (to separate smoking and nonsmoking sections) and offices.



OPTIONS

HEATING

- Unheatedpg 117
- Hot Waterpg 123
- Steampg 123

AT A GLANCE

Single Incremental Widths

30" to 10'

Max Installation Height

10'

Heavy Duty Motors

1/5 HP

KEY DESIGN FEATURES

- Meets ASHRAE 90.1 and IECC requirements for vestibule exception
- AMCA tested performance
- Low-profile outer cabinet constructed of 18-gauge 304 stainless steel with #3 finish
- 1/5 HP ODP (Open Drip Proof) direct-drive variable-speed motor(s)
- Adjustable air foil vane (+/-20°)
- Factory mounted single-stage electric heaters
- Single point power connection available (see electrical table)
- Alternate heater kW available (consult factory)

RECOMMENDED CONTROLS & ACCESSORIES

- Activation by 24V magnetic door switch
- SmartTouch Pro controller
- Filter (washable)

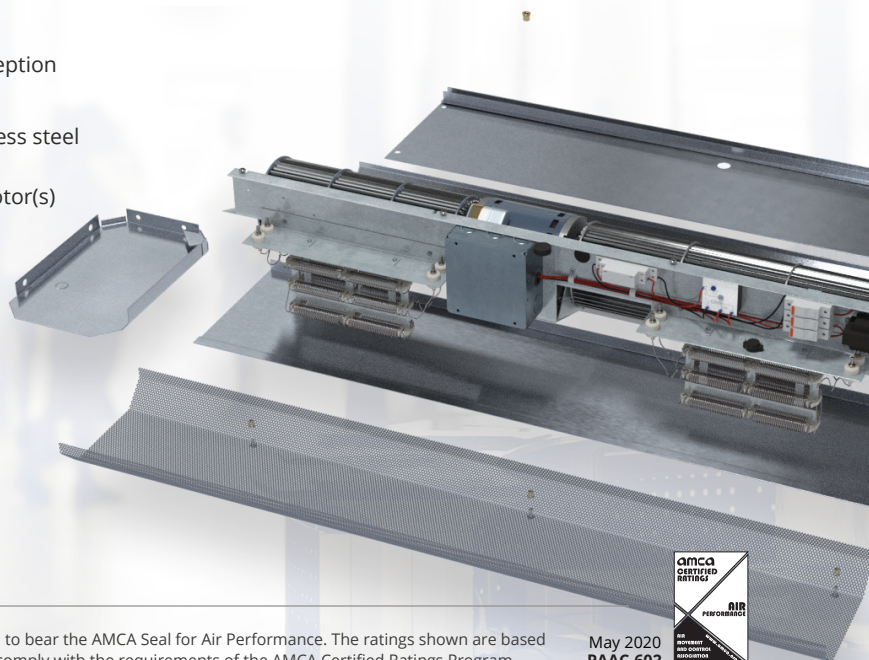

▶ MP-E | PERFORMANCE

MP-E | Performance Table

MODEL	Nozzle Width (in.)	Max. FPM at Nozzle	Avg. Outlet Velocity FPM	Airflow Rate (CFM)	Outlet Velocity Uniformity	Power Rating (kW)	Number of Motors	Motor HP	Weight (lbs)
MP-1-30E	29	3050	1243	746	66%	0.20	1	1/5	47
MP-1-36E	35	3262	1316	961	87%	0.27	1	1/5	59
MP-1-42E	41	3269	1294	1100	75%	0.29	1	1/5	69
MP-1-48E	48	3256	1386	1344	85%	0.33	1	1/5	77
MP-1-60E	59	3218	1406	1715	83%	0.54	1	1/5	91
MP-2-72E	71	3262	1316	1922	87%	0.54	2	1/5	102
MP-2-84E	83	3269	1294	2200	75%	0.58	2	1/5	115
MP-2-96E	95	3256	1386	2688	85%	0.66	2	1/5	123
MP-2-108E	107	3242	1397	3059	83%	0.87	2	1/5	139
MP-2-120E	117	3218	1406	3430	83%	1.08	2	1/5	152
MP-1-72E is not AMCA Certified									
MP-1-72E	71	3225	2104	2616	62%	n/a	1	1/5	100

! For Hot Water or Steam heat, consult factory.

MP-E | Velocity Projection

Distance From Nozzle	40"	80"	120"	160"
MP-1-36E Core Velocity (fpm)	990	738	659	542

MP-E | Sound Levels

Measured 10 ft. from unit in a free field based on a 1 motor unit 53 dBA

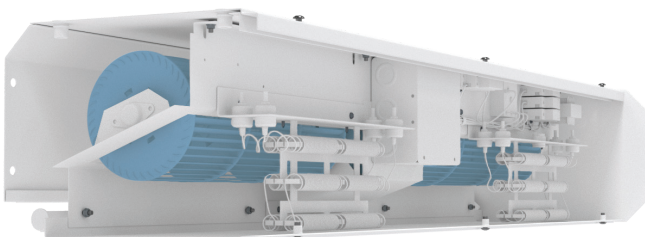

Performance Highlight

This unit can fit a larger diameter tangential blower wheel than competitors' models to increase performance without increasing size. The motor/blower plate comes out of the unit as an entire piece and the electrical connections can be made on the top or sides of the unit for more versatility.

The AMCA Certified Ratings Seal applies to airflow rate, average outlet velocity, outlet velocity uniformity, velocity projection and power rating at free delivery only. Rated data shown are based on tests of units with heating elements present but not in use.

Powered Aire Inc. certifies that the Model MP-E Air Curtain shown herein is licensed to bear the AMCA Seal for Air Performance. The ratings shown are based on tests and procedures performed in accordance with AMCA Publication 211 and comply with the requirements of the AMCA Certified Ratings Program.

May 2020
PAAC-602



MP-E | ELECTRICAL

AMP Draw, Circuits & Breaker Size Table

ALL AMP DRAWS LISTED BELOW INCLUDE TOTAL DRAW (MOTOR AND HEATERS INCLUDED)
* Single Point Power (SPP) includes branch fusing and may require remote control panel.
‡ High amp draws may be prohibitive. Reduced and custom kW available. Contact factory.

Models	AMP DRAW (Breaker Size)					
	kW	Temp Rise (°F)	208 / 1 / 60		240 / 1 / 60	
			Circuit		Circuit	
MP-1-30E	8.0	34	39.9A (50)		34.8A (45)	
	4.0	17	20.7 (30)		18.2A (25)	
MP-1-36E / 42E	8.0	23	40.5A (60)		35.3A (45)	
	4.0	12	21.2A (30)		18.7A (25)	
MP-1-48E / 60E	16.0	30	‡		‡	
	8.0	15	‡		‡	
MP-2-72E	16.0	27	‡		‡	
	8.0	13	‡		‡	
MP-2-84E	24.0	35	‡		‡	
	16.0	23	‡		‡	
	8.0	12	‡		‡	
MP-2-96E / 108E / 120E	32.0	30	‡		‡	
	24.0	22	‡		‡	
	16.0	14	‡		‡	

Models	AMP DRAW (Breaker Size)							
	kW	Temp Rise (°F)	208 / 3 / 60			240 / 3 / 60		
			Circuit 1	Circuit 2	SPP	Circuit 1	Circuit 2	SPP
MP-1-30E	8.0	34	23.1A (30)	-	-	20.7A (30)	-	-
	4.0	17	12.6A (20)	-	-	11.1A (15)	-	-
MP-1-36E / 42E	8.0	23	24.2A (35)	-	-	21.2A (30)	-	-
	4.0	12	13.1A (20)	-	-	11.6A (15)	-	-
MP-1-48E / 60E	16.0	30	46.4A (60)	-	-	40.5A (60)	-	-
	8.0	15	24.2A (35)	-	-	21.2A (30)	-	-
MP-2-72E	16.0	27	47.3A (60)	-	-	42.5A (60)	-	-
	8.0	13	26.2A (35)	-	-	23.2A (30)	-	-
MP-2-84E	24.0	35	26.2A (35)	44.4A (60)	70.6A (90)	23.2A (30)	38.5A (50)	61.7A (80)
	16.0	23	47.3A (60)	-	-	42.5A (60)	-	-
	8.0	12	26.2A (35)	-	-	23.2A (30)	-	-
MP-2-96E / 108E / 120E	32.0	30	47.3A (60)	43.3A (60)	90.6A (125)	42.5A (60)	38.5A (50)	81.0A (110)
	24.0	22	37.3A (50)	33.3A (45A)	70.6A (90)	32.8A (45)	28.8A (40)	61.7A (80)
	16.0	14	47.3A (60)	-	-	42.5A (60)	-	-

Models	AMP DRAW (Breaker Size)					
	kW	Temp Rise (°F)	480 / 3 / 60		575 / 3 / 60	
			Circuit		Circuit	
MP-1-30E	8.0	34	10.7A (15)		8.9A (15)	
	4.0	17	5.9A (15)		4.9A (15)	
MP-1-36E / 42E	8.0	23	10.7A (15)		8.9A (15)	
	4.0	12	5.9A (15)		4.9A (15)	
MP-1-48E / 60E	16.0	30	20.3A (30)		17.0A (25)	
	8.0	15	10.7A (15)		8.9A (15)	
MP-2-72E	16.0	27	21.4A (30)		17.9A (25)	
	8.0	13	11.8A (15)		9.8A (15)	
MP-2-84E	24.0	35	31.1A (40)		25.9A (35)	
	16.0	23	21.4A (30)		17.9A (25)	
	8.0	12	11.8A (15)		9.8A (15)	
MP-2-96E / 108E / 120E	32.0	30	40.7A (60)		33.9A (45)	
	24.0	22	31.1A (40)		25.9A (35)	
	16.0	14	21.4A (30)		17.9A (25)	



Consult factory for disconnects on electrically heated MP air curtains.

▶ MP & MP-E | MECHANICAL DETAILS & DRAWINGS

MP & MP-E | Mechanical Information Table

MODEL	Overall Width (in.)	Mounting Width (in.)	Nozzle Width (in.)
MP-1-30 (E)	31	30	29
MP-1-36 (E)	37	36	35
MP-1-42 (E)	43	42	41
MP-1-48 (E)	49	48	47
MP-1-60 (E)	61	60	59
MP-1-72 (E)	73	72	71
MP-2-72 (E)	73	72	71
MP-2-84 (E)	85	84	83
MP-2-96 (E)	97	96	95
MP-2-108 (E)	109	108	107
MP-2-120 (E)	119	118	117

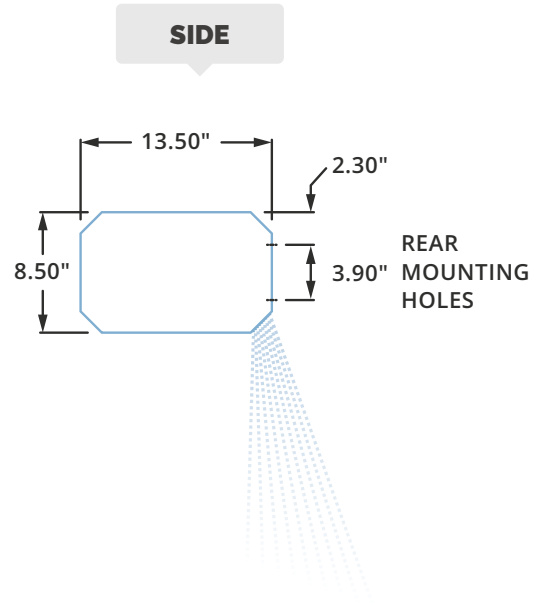

TOP

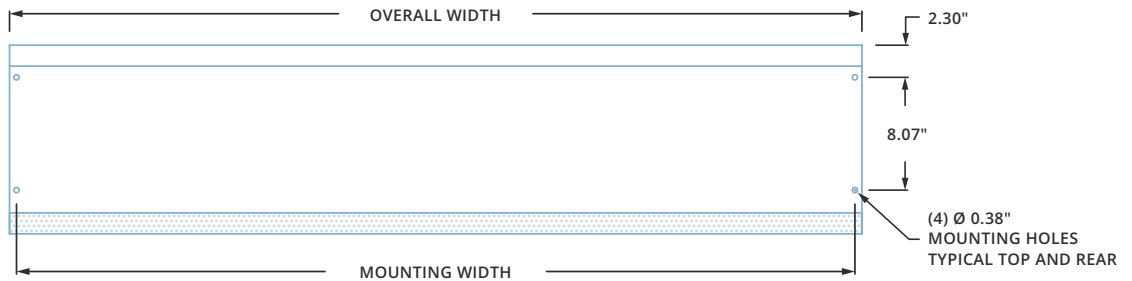

FRONT

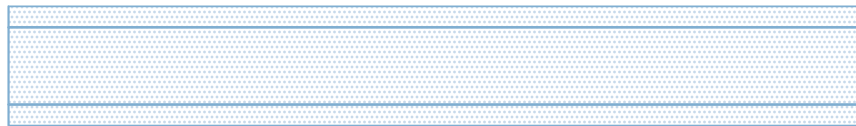

BOTTOM

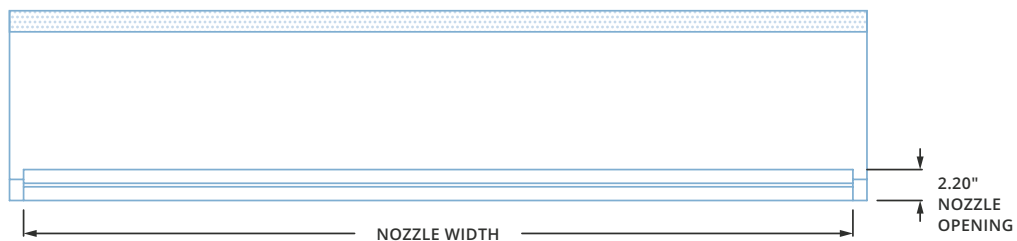

▶ MP, MP-E & MP-HW/ST | INSTALLATION



IMPORTANT

- ✓ **NOTE:** The air curtain should be mounted as close to the door header/opening as possible for maximum performance. For every one inch the bottom of the air curtain is mounted above the door header, the back side of the air curtain should be moved away from the wall ¼ inch.
- ✓ Trained and experienced mechanic / electrician required.
- ✓ **WARNING:** Risk of electrical shock, can cause injury or death: Disconnect all remote electrical supplies before servicing.
- ✓ Units must be field wired in accordance with all applicable local, state, provincial and national codes, including wire size and materials.
- ✓ All hardware and brackets must be of sufficient strength to safely support air curtain.

A TOP MOUNT

Unit has four 3/8 - 16 threaded inserts for installing one end of threaded rods. The other ends of the threaded rods can be attached to the ceiling. Threaded rod should not extend more than 3/4 inch into air curtain.

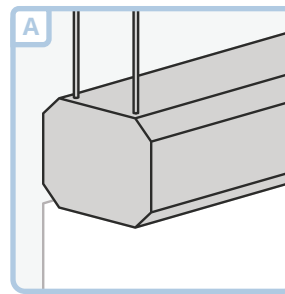

B WALL MOUNT

Back side of air curtain has 4 mounting holes capable of accepting four 3/8 mounting bolts or lags, with washers (use these holes only for mounting). Mark and pre-drill mounting surface accurately. A long extension and ratchet will negate the need to remove the motor/blower plate when installing. Mounting bolts or lags of sufficient size and strength should be installed and tightened through the four slots in motor/blower plate.

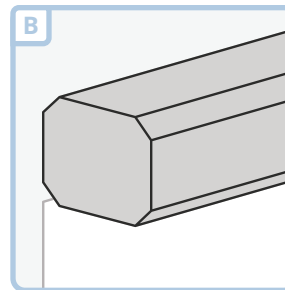

If motor/blower plate has to be removed, the junction box inside the unit must be removed along with any electrical switches that may be in the way. Remove 7/16 whizlock nuts holding plate in place, and slide plate out, rotating top portion of plate so it comes out first. Remember when installing plate to put bottom of plate in first and push and rotate top in last.

C EXTENSION BRACKETS (WALL MOUNT)

Extension brackets bolt on to the back of the unit, utilizing the 4 original mounting holes, and allowing for external mounting of unit to wall. Brackets have elongated mounting slots that extend the mounting width by 2½ to 3½ inches.

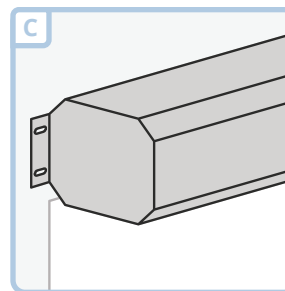

D LP123 BRACKETS

Universal mounting slots are used to lag the bracket to the wall (bolts by others). 3/8" mounting bolts (supplied) are threaded into the holes located in all four corners of the back side of the air curtain, leaving 1/2" of the bolts exposed.

